

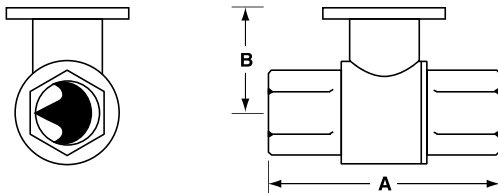

Technical Data	
Service	chilled or hot water, 60% glycol
Flow characteristic	A-port equal percentage
Action	90° rotation
Sizes	½", ¾", 1", 1¼", 1½", 2", 2½", 3"
Type of end fitting	NPT female ends
Materials:	
Body	forged brass, nickel plated
Ball	stainless steel
Stem	stainless steel
Seats	PTFE
Characterizing disc	Tefzel®
Packing	2 EPDM O-rings, lubricated
Body pressure rating	
600 psi	½" - 1¼" (B230)
400 psi	1¼" (B231) - 3"
Media temp. range	0°F to 212°F [-18°C to 100°C]
Close off pressure	
200 psi	½" - 2" (B250)
100 psi	2" (B251) - 3"
Maximum differential pressure (ΔP)	30 psi for typical applications
Leakage	0% for A to AB
External leakage	according to EN 12266-1:2003
C _v rating	A-port: see product chart for values

Tefzel® is a registered trademark of DuPont

Dimensions



2WayValve-B207-B220

Valve Body	Valve Nominal Size		Dimensions (Inches [mm])	
	Inches	DN [mm]	A	B
B207-B211	½"	15	2.41" [61.1]	1.39" [35.2]
B212-B215	½"	15	2.38" [60.4]	1.78" [45.2]
B217-B220	¾"	20	2.73" [69.3]	1.87" [47.4]
B222-B225	1"	25	3.09" [78.4]	1.87" [47.4]
B229-B230	1¼"	32	3.72" [94.6]	1.87" [47.4]
B231-B232	1¼"	32	3.72" [94.6]	2.04" [51.9]
B238-B240	1½"	40	3.88" [98.5]	2.04" [51.9]
B248-B250	2"	50	4.21" [107.0]	2.27" [57.7]
B251-B254	2"	50	4.93" [125.2]	2.73" [69.5]
B261-B265	2½"	65	5.55" [140.9]	2.73" [69.5]
B277-B280	3"	80	5.82" [147.9]	2.73" [69.5]

C _v	Valve Nominal Size		Type	Suitable Actuators	
	Inches	DN [mm]	2-Way NPT	Non-Spring	Spring
0.3	½"	15	B207	TR Series	
0.46	½"	15	B208		
0.8	½"	15	B209		
1.2	½"	15	B210		
1.9	½"	15	B211		
3	½"	15	B212		
4.7	½"	15	B213		
7.4	½"	15	B214		
10	½"	15	B215*		
4.7	¾"	20	B217		
7.4	¾"	20	B218		
10	¾"	20	B219		
24	¾"	20	B220*		
7.4	1"	25	B222		
10	1"	25	B223		
19	1"	25	B224		
30	1"	25	B225*		
10	1¼"	32	B229		
19	1¼"	32	B230*		
25	1¼"	32	B231		
37	1¼"	32	B232*		
19	1½"	40	B238		
29	1½"	40	B239		
37	1½"	40	B240*		
29	2"	50	B248		
46	2"	50	B249		
57	2"	50	B250*		
65	2"	50	B251		
85	2"	50	B252		
120	2"	50	B253		
240	2"	50	B254*		
60	2½"	65	B261		
75	2½"	65	B262		
110	2½"	65	B263		
150	2½"	65	B264		
210	2½"	65	B265*		
70	3"	80	B277		
130	3"	80	B278		
170	3"	80	B280*		

*Models without characterizing disc

Flow Patterns

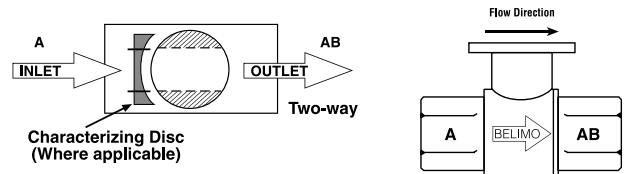

M40013 - 06/11 - Subject to change. © Belimo Aircontrols (USA), Inc.

ARB24-SR-T N4 NEMA 4X Actuators, Proportional



Models

ARB24-SR-T N4
ARB24-SR-T N4H w/built in heater

Technical Data	
Power supply	24 VAC ± 20% 50/60 Hz 24 VDC ± 10%
Power consumption	running 2.5 W / heater 23 W holding 0.4 W
Transformer sizing	5 VA (class 2 power source) / heater 20 VA
Electrical connection	screw terminal (for 26 tp 14 GA wire)
Overload protection	electronic throughout 0° to 95° rotation
Operating range Y	2 to 10 VDC, 4 to 20 mA
Input impedance	600 Ω
Angle of rotation	90°, adjustable with mechanical stop
Direction of rotation	reversible with switch
Position indication	visual pointer
Manual override	external push button
Running time	90 seconds constant independent of load
Humidity	100% RH
Ambient temperature	-22°F to 122°F [-30°C to 50°C]
Storage temperature	-40°F to 176°F [-40°C to 80°C]
Housing type	UL Type 4X/NEMA 4X/IP66 & IP67
Housing material	Polypropylene
Agency listings†	cULus according to UL 60730-1A/-2-14, CAN/CSA E60730-1, CSA C22.2 No. 24-93, CE according to 89/336/EEC.
Quality standard	ISO 9001

†Rated Impulse Voltage 800V, Type of action 1, Control Pollution Degree 3
*Cannot be used with the CCV-EXT-KIT

Dimensions with 2-Way Valve

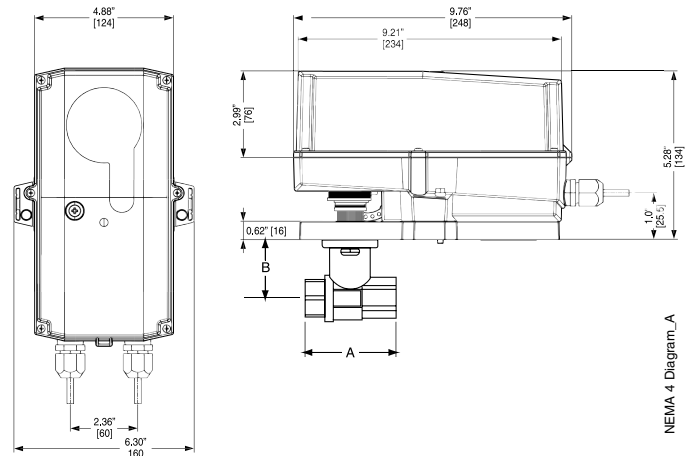

Valve Body	Valve Nominal Size		Dimensions (Inches [mm])	
	Inches	DN [mm]	A	B
B231-B232	1¼"	32	3.72" [94.6]	2.04" [51.9]
B238-B240	1½"	40	3.88" [98.5]	2.04" [51.9]
B248-B250	2"	50	4.21" [107.0]	2.27" [57.7]
B251-B254	2"	50	4.93" [125.2]	2.73" [69.5]
B261-B265	2½"	65	5.55" [140.9]	2.73" [69.5]
B277-B280	3"	80	5.82" [147.9]	2.73" [69.5]

Dimensions with 3-Way Valve

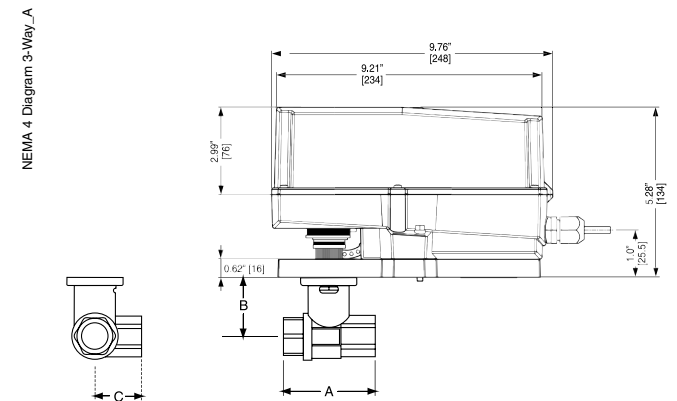

Valve Body	Valve Nominal Size		Dimensions (Inches [mm])		
	Inches	DN [mm]	A	B	C
B329-B331	1¼"	32	3.96" [100.6]	2.27" [57.7]	2.14" [54.3]
B338-B341	1½"	40	4.39" [111.6]	2.51" [63.7]	2.40" [61.1]
B347-B352	2"	50	4.90" [124.5]	2.73" [69.5]	2.74" [69.7]

M40013 - 06/11 - Subject to change. © Belimo Aircontrols (USA), Inc.

Wiring Diagrams

✂ INSTALLATION NOTES

- ⚠ **CAUTION Equipment damage!**
Actuators may be connected in parallel.
Power consumption and input impedance must be observed.
- ⚠ **3** Actuators may also be powered by 24 VDC.
- ⚠ **5** Only connect common to neg. (-) leg of control circuits.

📄 APPLICATION NOTES

- ◆ The ZG-R01 500 Ω resistor converts the 4 to 20 mA control signal to 2 to 10 VDC, up to 2 actuators may be connected in parallel.

⚠ WARNING Live Electrical Components!
During installation, testing, servicing and troubleshooting of this product, it may be necessary to work with live electrical components. Have a qualified licensed electrician or other individual who has been properly trained in handling live electrical components perform these tasks. Failure to follow all electrical safety precautions when exposed to live electrical components could result in death or serious injury.

Wiring Diagrams

with actuator types ...3

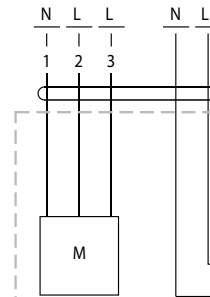

Legend:
M = actuator
T (°C) = Thermostat
H = Heating

Note
The following points must be taken into account with independent, external wiring:

- All contact between the cables or wires that are introduced and the heating element is to be avoided.
- Where necessary, use cables with sufficient numbers of wires, e.g. so that the heating and the actuator can be supplied separately with voltage.

Heater wiring

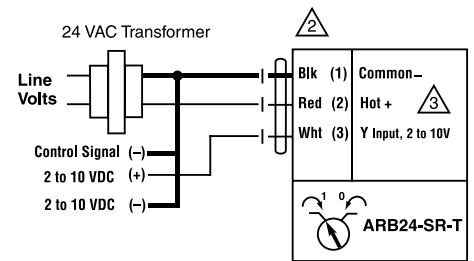

2 to 10 VDC control

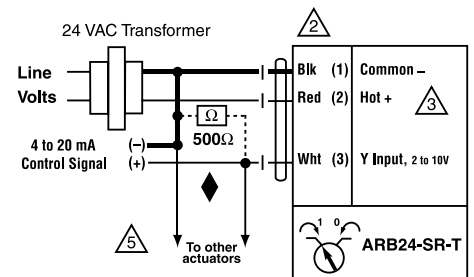

4 to 20 mA control

M40013 - 06/11 - Subject to change. © Belimo Aircontrols (USA), Inc.

W408-SR-T

W408-SR-T