

# Electronic Pressure Independent Valve (ePIV)



## ePIV with Non-Spring Return and Electronic Fail-Safe Actuators

- AR, GR, AKR, GKR Series

# Installation Instructions

## Flanged Characterized Control Valves™



### General Warnings

**Valve should not be used for combustible gas applications. Gas leaks and explosions may result. Do not install in systems, which exceed the ratings of the valve.**

- Avoid installations where valve may be exposed to excessive moisture, corrosive fumes, vibration, high ambient temperatures, elements, or high traffic areas with potential for mechanical damage.
- Valve assembly location must be within ambient ratings of actuator. If temperature is below -22°F a heater is required.
- The valve assembly will require heat shielding, thermal isolation, or cooling if combined effect of medium and ambient temperatures – conduction, convection, and radiation– is above 122°F for prolonged time periods at the actuator.
- Visual access must be provided. Assembly must be accessible for routine schedule service. Contractor should provide unions for removal from line and isolation valves.
- Avoid excessive stresses. Mechanical support must be provided where reducers have been used and the piping system may have less structural integrity than full pipe sizes.
- Sufficient upstream piping runs must be provided to ensure proper valve capacity and flow response. See installation section for details.
- Life span of valve stems and O-rings is dependent on maintaining non-damaging conditions. Poor water treatment or filtration, corrosion, scale, other particulate can result in damage to trim components. A water treatment specialist should be consulted.
- It is not necessary to install one strainer per unit. Belimo recommends installing one strainer per system. If the system has multiple branches, it is recommended to install one strainer per branch.

1. Inspect shipping package, valve, linkage, and actuator for physical damage. If shipping damage has occurred notify appropriate carrier. Do not install.
2. If a replacement, remove existing valve, linkage and actuator from the piping system.
3. If actuator and linkage are removed, they must be reinstalled correctly. The actuator must be rotated so that the valve seats properly for close off.
4. Install valve with the proper ports as inlets and outlets. Check that inlet and outlet of 2-way valves are correct. Flow direction arrows must be correct.
5. Blow out all piping and thoroughly clean before valve installation.
6. Clean flanges with wire brush and rag. Clean pipes, flanges, and valve flanges before installation; check for any foreign material that can become lodged in trim components. Strainers should be cleaned after initial startup.
7. Valve must be installed with the stem towards the vertical, not below horizontal.
8. These valves are designed to be installed between ANSI Class 125/150 flanges.
9. Carefully follow installation using ANSI piping practices.

**WARNING: Lift ePIV from valve body. Do not lift this valve by the actuator. Lifting the valve body by the actuator can break the linkage and void the warranty.**



### Valve Specifications

Service	chilled or hot water, 50% glycol max (closed loop/steam not allowed)
Flow characteristic	equal percentage / linear
Controllable flow range	90° rotation
Size	2½", 3", 4", 5", 6"
Type of end fitting	pattern to mate with ANSI 125 flange
Materials	
Body	cast iron - GG25 and ductile iron - GGG50
Ball	stainless steel
Seat	PTFE
Characterizing disc	stainless steel
Packing	2 EPDM O-rings, lubricated
Body pressure rating	according to ANSI 125, standard class B
Media temp. range	36°F to 250°F [2°C to 120°C]
Conductivity	Min. 20uS/cm (no fully desalinated systems)
Leakage	0%
Differential pressure range(ΔP)	5 to 50 psid
Inlet length required in front of valve	5x DN
Power supply for the flow sensor	sensor is powered by the actuator

### Application

Water-side control of heating and cooling systems for AHUs and heat pumps.  
Equal Percentage: Heating / cooling applications.  
Linear Characteristic: Bypass control.

### Mode of Operation

The Electronic Pressure Independent Control Valve is a two-way valve which is unaffected by pressure variations in a system.

### Product Features

Constant flow regardless of pressure variations in the system. Maximizes chiller ΔP, preventing energizing additional chillers due to low ΔT. Simplified valve sizing and selection, no Cv calculations required.

### Dimensions

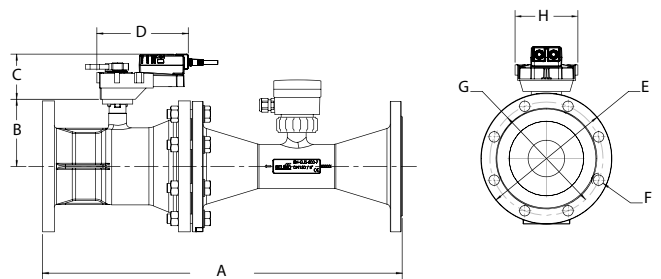

Valve Nominal Size		Dimensions (Inches [mm])							
In.	DN [mm]	A	B	C	D	E	F	G	H
4"	100	22.85 [580.5]	4.88 [124]	3.29 [83.7]	6.83 [173.4]	7.50 [190.5]	0.75 [19]	7.50 [190.5]	3.74 [95]
5"	125	25.18 [639.5]	5.63 [143]	3.79 [96.2]	7.68 [194.9]	10.0 [254]	0.88 [22.4]	8.50 [215.9]	5.28 [134]
6"	150	30.2 [767]	5.63 [143]	3.79 [96.2]	7.68 [194.9]	11.0 [279.4]	0.88 [22.4]	9.50 [241.3]	5.28 [134]

### Dimensions

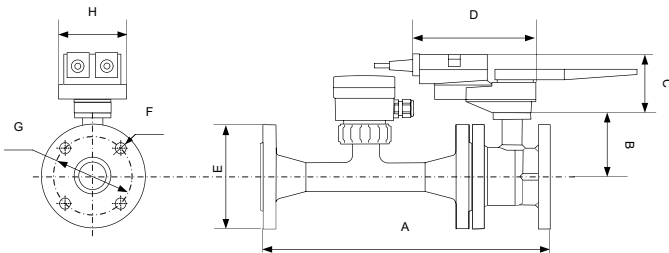

Valve Nominal Size		Dimensions (Inches [mm])							
In.	DN [mm]	A	B	C	D	E	F	G	H
2½"	65	17.9 [454]	4.50 [113]	2.68 [68]	6.81 [173]	7.28 [185]	0.75 [19.05]	5.50 [140]	3.70 [95]
3"	80	19.7 [499]	4.50 [113]	2.68 [68]	6.81 [173]	7.87 [200]	0.75 [19.05]	6.07 [154]	3.70 [95]

### Weights

Valve Nominal Size		Weights
Inches	DN [mm]	Pounds [kg]
2½"	65	52.0 [23.3]
3"	80	63.0 [28.3]
4"	100	89.0 [40.1]
5"	125	120.0 [54.3]
6"	150	154.0 [69.6]

# P6... Series Electronic Pressure Independent Valves (ePIV) Stainless Steel Ball, ANSI 125 Flange Ends



## Non-Spring Return Actuators

AR Series  
GR Series

Actuator Specifications	
Power supply	24 VAC ± 20% 24 VDC ± 10%
Electric Frequency	60 Hz Only
Power consumption	
AR Series	6.5W
GR Series	9W
Transformer sizing	20 VA (class 2 power source)
Electrical connection	18 GA, Plenum rated cable ½" conduit connector protected NEMA 2 (IP54) 3ft [1m] cable
Overload protection	electronic throughout 0° to 90° rotation
Operation range Y	2 to 10 VDC (default) VDC variable
Control	Proportional
Input impedance	100 kΩ (0.1 mA), 500Ω
Feedback	2 to 10VDC (default), VDC variable
Torque	
AR Series	180 in-lb [20Nm]
GR Series	360 in-lb [40Nm]
Direction of rotation	electronically variable
Fail-safe position	none
Manual override	external push button
Running time normal operation	90 seconds
Running time fail-safe	none
Humidity	5 to 95% RH, non-condensing
Ambient temperature	-22°F to 122°F [-30°C to 50°C]
Storage temperature	-40°F to 176°F [-40°C to 80°C]
Housing type	NEMA 2, IP54, UL enclosure type 2
Agency listings	cULus acc. to UL60730-1A/-2-14, CAN/CSA, CE acc. to 2004/108/EC and 2006/95/EC
Noise level	<45dB(A) at 90 seconds
Servicing	maintenance free
Quality standard	ISO 9001
Weight	
AR Series	2.65 lb [1.2 kg]
GR Series	4.85 lb [2.2 kg]

The ZTH-GEN and the PC-Tool are tools created to easily adapt the flow settings for the ePIV in the field. It directly connects to the Belimo actuator.

## Operation

The actuator is electronically protected against overload. The anti-rotation strap supplied with the actuator will prevent lateral movement.

The GKR and AKR series actuators use a brushless DC motor, which is controlled by an Application Specific Integrated Circuit (ASIC). The ASIC monitors and controls the actuators rotation and provides a digital rotation sensing (DRS) function to prevent damage to the actuator in a stall condition. Power consumption is reduced in a holding mode.

Add-on auxiliary switches or feedback potentiometers are easily fastened directly onto the actuator body for signaling and switching functions.

## Electronic Fail-Safe Actuators

AKR Series  
GKR Series

Actuator Specifications	
Power supply	24VAC ±20% 24VDC ±10%
Electric Frequency	60 Hz Only
Power consumption	
AKR Series	12W
GKR Series	14W
Transformer sizing	24 VA (class 2 power source)
Electrical connection	18 GA plenum rated cable ½" conduit connector protected NEMA 2 (IP54) 3 ft [1m] 10 ft [3m] 16 ft [5m]
Overload protection	electronic throughout 0° to 90° rotation
Operation range Y	2 to 10VDC (default), VDC variable
Input impedance	100 kΩ (0.1 mA), 500Ω
Feedback output U	2 to 10VDC, 0.5mA max, VDC variable
Torque	
AKR Series	180 in-lb [20Nm]
GKR Series	360 in-lb [40 Nm]
Direction of rotation	electronically variable
Fail-safe position	adjustable with dial or tool 0 to 100% in 10% increments
Manual override	external push button
Running time normal operation	90 seconds
Running time fail-safe	35 seconds
Humidity	5 to 95% RH non-condensing
Ambient temperature	-22°F to +122°F [-30°C to +50°C]
Storage temperature	-40°F to +176°F [-40°C to +80°C]
Housing	NEMA2, IP54, UL enclosure type 2
Agency list	cULus acc. to UL 60730-1A/-2-14 CAN/CSA E60730-1:02 CE acc. to 2004/108/EEC and 2006/95/EC
Noise level	< 45dB(A)
Servicing	maintenance free
Quality standard	ISO 9001
Weight	
AKR Series	3.30 lb [1.5 kg]
GKR Series	5.51 lb [2.5 kg]

09/10 - Subject to change. © Belimo Aircontrols (USA), Inc.

## Wiring Diagrams

### INSTALLATION NOTES

- 1 Provide overload protection and disconnect as required.
- 2 **CAUTION Equipment damage!**  
Actuators may be connected in parallel.  
Power consumption and input impedance must be observed.
- 3 Actuators may also be powered by 24 VDC.
- 4 Actuators are provided with color coded wires.  
Wire numbers are provided for reference.

### APPLICATION NOTES

- ◆ Non-Spring Return Actuators:  
Up to 2 actuators may be connected in parallel.  
Meets cULus or UL and CSA requirements.
- ◆ Meets UL requirements without the need of an electrical ground connection.
- ◆ The ZG-R01 500 Ω resistor may be used.

### WARNING Live Electrical Components!

During installation, testing, servicing and troubleshooting of this product, it may be necessary to work with live electrical components. Have a qualified licensed electrician or other individual who has been properly trained in handling live electrical components perform these tasks. Failure to follow all electrical safety precautions when exposed to live electrical components could result in death or serious injury.

## System Ground

In cases where the valve body is electrically isolated from the water pipe, an earth ground should be installed in order for the sensor to work properly. Earth ground can be connected directly on the sensor body. A connection point is provided on the flange of the sensor body.

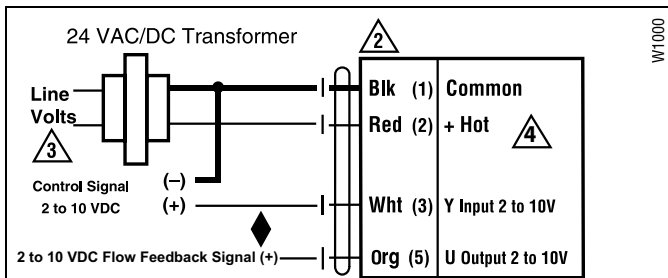

2 to 10 VDC control signal for Non-Spring Return and Electronic Fail-Safe

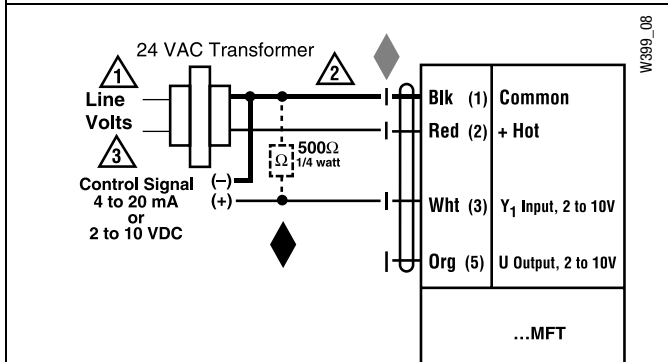

4 to 20 mA control signal for Non-Spring Return and Electronic Fail-Safe

## Set-Up

		2-WAY VALVE			
NON-SPRING RETURN STAYS IN LAST POSITION	ARB... Series GRB... Series	NC*: Valve Closed-will open as voltage increases.	NO*: Valve Open-will close as voltage increases.		
	AKR... Series GKR... Series	NC/FO* Valve: Valve Closed-will open as voltage increases. Fail Action: Will fail open upon power loss.	NC/FC* Valve: Valve Closed-will open as voltage increases. Fail Action: Will fail closed upon power loss.	NO/FC* Valve: Valve Open-will close as voltage increases. Fail Action: Will fail closed upon power loss.	NO/FO Valve: Valve Open-will close as voltage increases. Fail Action: Will fail open upon power loss.

\*Feedback signal is always NC

## Functionality

The ePIV provides pressure independence by combining a magnetic flow meter and a 2-way control valve. The actuator has a powerful algorithm that modulates the control valve to maintain the exact flow based on the control signal set by the DDC Controller. The flow reading is reported back to the controller using a standard signal, and this value can be used by the Building Automation System to perform advanced control and energy strategies.

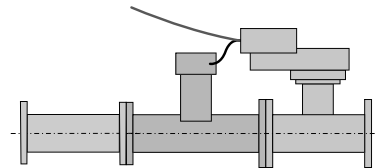

## Flow Characteristics and Tolerances

Flow Control Tolerance of the ePIV:  
 +/-10% of the actual Flow  
 Flow measurement tolerance +/- 6% of the nominal flow.

V'nom = flow rating of valve as listed in catalog

The ePIV has an equal percentage flow curve. The equal percentage curve offers a more stable control for heating and cooling applications. The flow characteristic can be changed from equal percentage to linear using the Belimo PC-Tool. Linear flow characteristic is used when controlling applications different than cooling/heating coils; like bypass control.

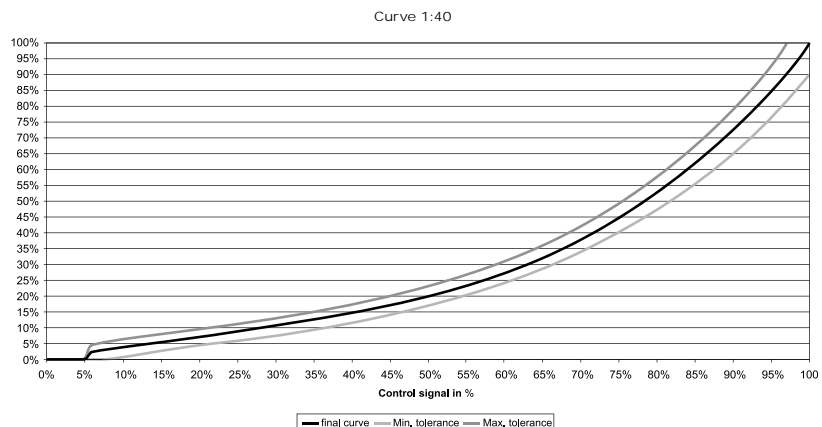

09/10 - Subject to change. © Belimo Aircontrols (USA), Inc.

# Equal Percentage, Control Signal Vs. Flow Percentage

Controller Signal Actuator Feedback: Y/U5			Controller Signal Actuator Feedback: Y/U5			Controller Signal Actuator Feedback: Y/U5		
0.5-10 VDC Signal	2-10 VDC Signal	Water Flow in %	0.5-10 VDC Signal	2-10 VDC Signal	Water Flow in %	0.5-10 VDC Signal	2-10 VDC Signal	Water Flow in %
0.50	2.00	0%	3.73	4.72	12%	6.96	7.44	36%
0.60	2.08	0%	3.83	4.80	12%	7.06	7.52	37%
0.69	2.16	0%	3.92	4.88	13%	7.15	7.60	38%
0.79	2.24	0%	4.02	4.96	13%	7.24	7.68	39%
0.88	2.32	0%	4.11	5.04	14%	7.34	7.76	41%
0.98	2.40	0%	4.21	5.12	14%	7.43	7.84	42%
1.07	2.48	0%	4.30	5.20	15%	7.53	7.92	43%
1.17	2.56	2%	4.40	5.28	15%	7.62	8.00	45%
1.26	2.64	3%	4.49	5.36	15%	7.72	8.08	46%
1.36	2.72	3%	4.59	5.44	16%	7.81	8.16	48%
1.45	2.80	4%	4.68	5.52	16%	7.91	8.24	49%
1.55	2.88	4%	4.78	5.60	17%	8.00	8.32	51%
1.64	2.96	4%	4.87	5.68	18%	8.10	8.40	53%
1.74	3.04	5%	4.97	5.76	18%	8.20	8.48	54%
1.83	3.12	5%	5.06	5.84	19%	8.29	8.56	56%
1.93	3.20	5%	5.16	5.92	19%	8.39	8.64	58%
2.02	3.28	6%	5.25	6.00	20%	8.48	8.72	60%
2.12	3.36	6%	5.35	6.08	21%	8.58	8.80	62%
2.21	3.44	6%	5.44	6.16	21%	8.67	8.88	64%
2.31	3.52	7%	5.54	6.24	22%	8.77	8.96	66%
2.40	3.60	7%	5.63	6.32	23%	8.86	9.04	68%
2.50	3.68	7%	5.73	6.40	24%	8.96	9.12	70%
2.59	3.76	8%	5.82	6.48	24%	9.05	9.20	73%
2.69	3.84	8%	5.92	6.56	25%	9.15	9.28	75%
2.78	3.92	8%	6.01	6.64	26%	9.24	9.36	77%
2.88	4.00	9%	6.11	6.72	27%	9.34	9.44	80%
2.97	4.08	9%	6.20	6.80	28%	9.43	9.52	83%
3.07	4.16	9%	6.30	6.88	29%	9.53	9.60	85%
3.16	4.24	10%	6.39	6.96	29%	9.62	9.68	88%
3.26	4.32	10%	6.49	7.04	30%	9.72	9.76	91%
3.35	4.40	11%	6.58	7.12	31%	9.81	9.84	94%
3.45	4.48	11%	6.68	7.20	32%	9.91	9.92	97%
3.54	4.56	11%	6.77	7.28	33%	10.00	10.00	100%
3.64	4.64	12%	6.87	7.36	35%			

09/10 - Subject to change. © Belimo Aircontrols (USA), Inc.

## Installation

### Inlet Length

The ePIV requires a section of straight pipe on the valve inlet to guarantee sensor accuracy. The length should be at least 5 diameters long.

DN65 5 x DN = 12.5" [317mm]

DN80 5 x DN = 15" [381mm]

DN100 5 x DN = 20" [508mm]

DN125 5 x DN = 25" [635mm]

DN150 5 x DN = 30" [762mm]

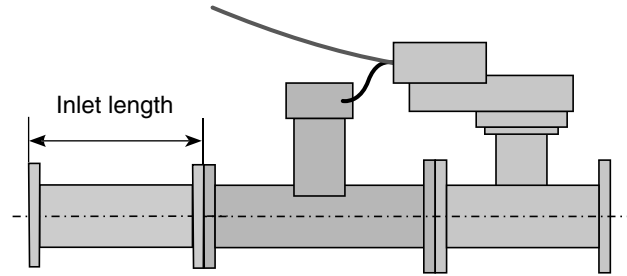

### Output Length

No requirements for outlet length. Elbows can be installed directly after the valve.

## Actuator & Flow Sensor Removal

During the installation the actuator and the flow sensor can be removed from the valve. The two components should be removed together and the sensor wire should not be disconnected from the actuator since this can damage the connectors.

The sensor and valve bodies should not be disassembled. Disassembly can damage the valve components and will void the warranty.

When assembling the flow sensor back in the body the holding nut should be hand tightened. No tools should be used to tighten the nut. This can damage the thread of the nut.

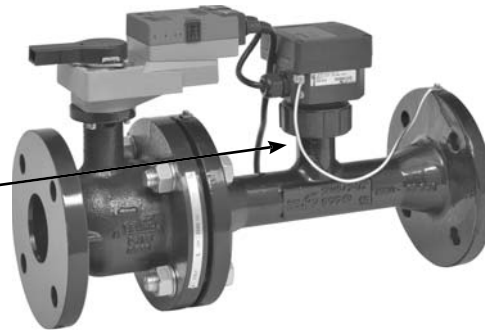

## Orientation

ePIVs shall be installed with flow in the direction of the arrow on the valve body.

The valve assembly can be installed in a vertical or horizontal arrangement, as long as the actuator is positioned to avoid condensation from dripping onto the actuator.

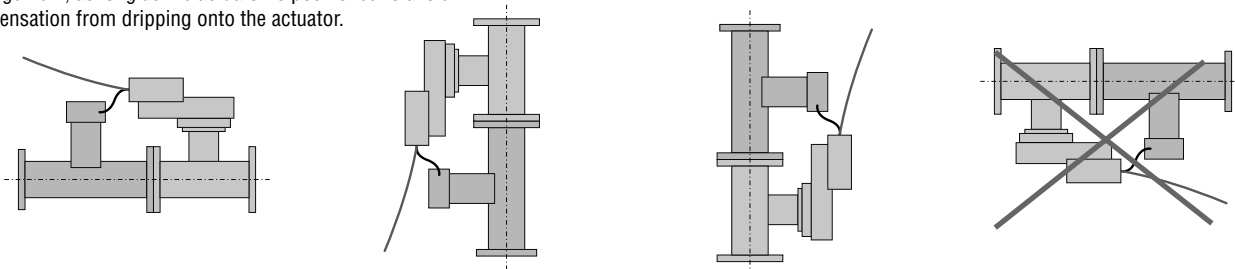



## Piping

The ePIV is recommended to be installed on the return side of the coil. This diagram is for typical applications only. Consult engineering specification and drawings for particular circumstances. P/T ports are recommended on either side of the valve and the supply side of the heat transfer device to allow for pressure/flow measurement/calculation. Refer to Belimo documentation for flow verification and commissioning procedures.

It is not necessary to install one strainer per unit. Belimo recommends installing one strainer per system. If the system has multiple branches, it is recommended to install one strainer per branch.

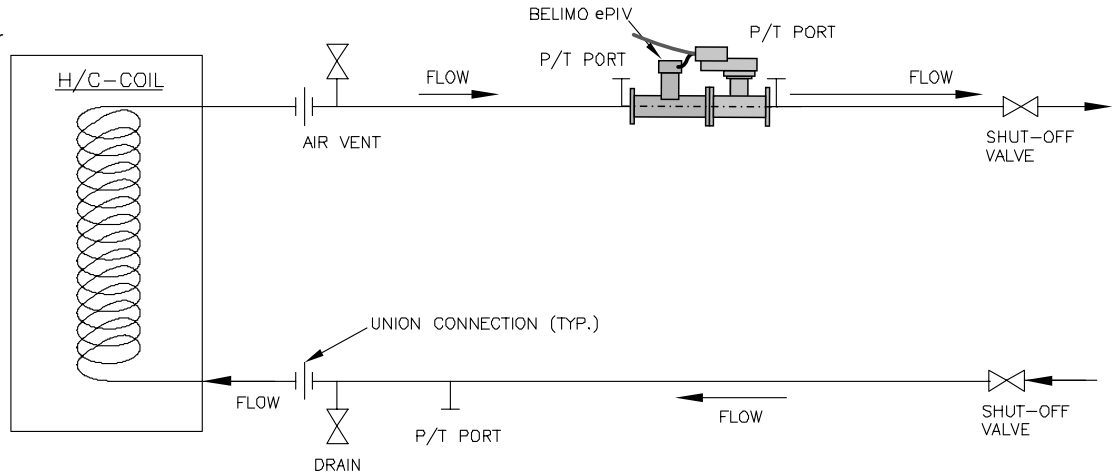

The Electronic Pressure Independent Valves can be piped in a parallel orientation to achieve increased flow rates.

## Typical Parallel Piping in Relation to the Input and Output

To achieve flows larger than  $V_{nom}$  or nominal flow, it is recommended to connect two valves in parallel leading to a common manifold. To correctly operate these valves, the Multi-Function Technology (MFT) will be employed to utilize one common control signal. It is recommended to use the same signal in parallel (2-10 VDC); the two actuators are wired from the same control signal and the two valves control the flow in an identical pattern, the resulting flow will be the double controlled by an individual valve. This arrangement is preferable to a split signal since it offers a more stable and accurate flow and feedback signal is easier to interpret.

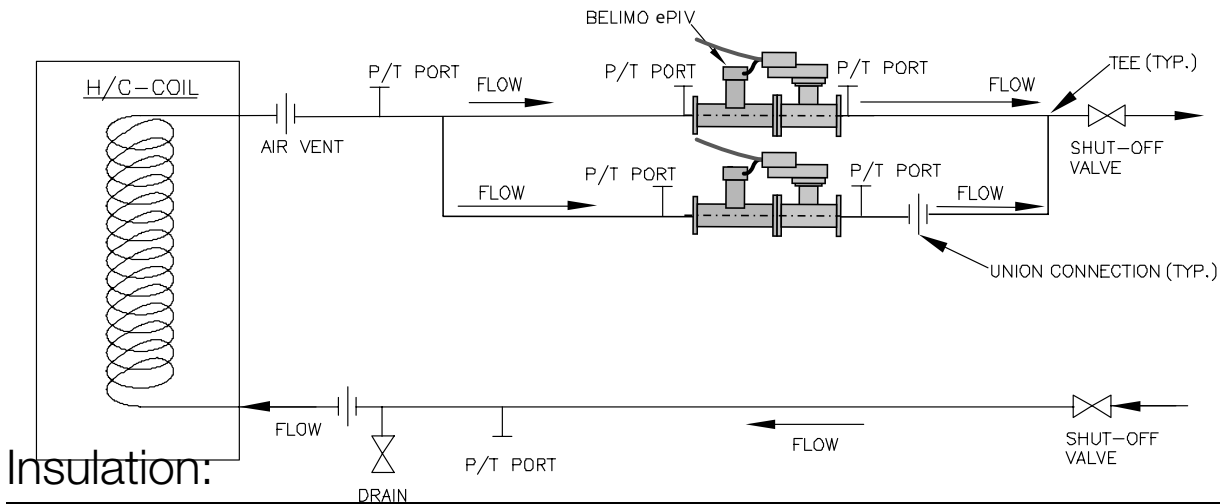

**Insulation:**

The insulation should be below the actuator.

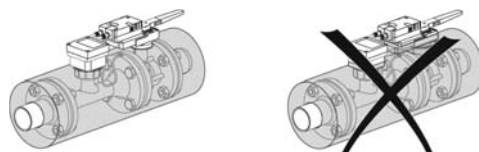

09/10 - Subject to change. © Belimo Aircontrols (USA), Inc.

The ZTH-GEN is a tool created to easily adapt the flow settings for the ePIV in the field. It directly connects to the Belimo actuator.

CONNECTION PROCESS:



**AR, GR, AK, GK Series**

Use the interface on the top of the actuator. (Leave all of the wires of the actuator installed.)



**Technical Information**

Supply	24 VAC/DC
Communication	PP
Used with actuator types	ARB24 GRB24 AKRB24 GKRB24

RE-PROGRAMMING PROCESS:

**Initial Screen**

Connect cable to actuator port, twist to lock in place. Will display the handheld software and hardware versions for 5 seconds then it will display the actuator being connected

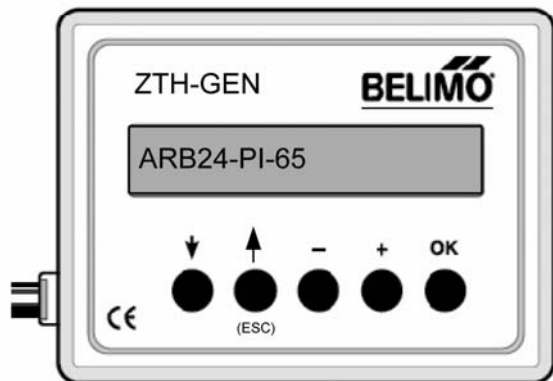

**Screen 1**

Start ePIV process by pressing the up arrow (ESC) The first screen displays the MFT address, press ESC to continue to the next screen.

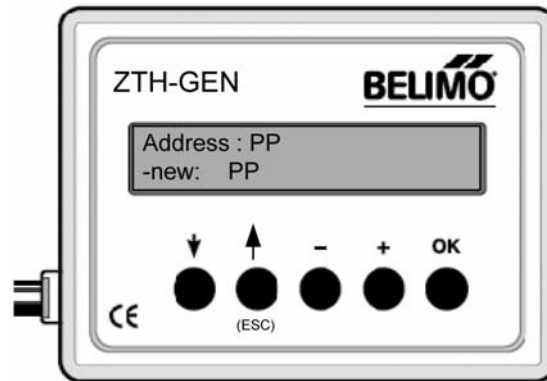

**Screen 2**

To change the Vmax value press the – button until you reach the required value then press the OK button.

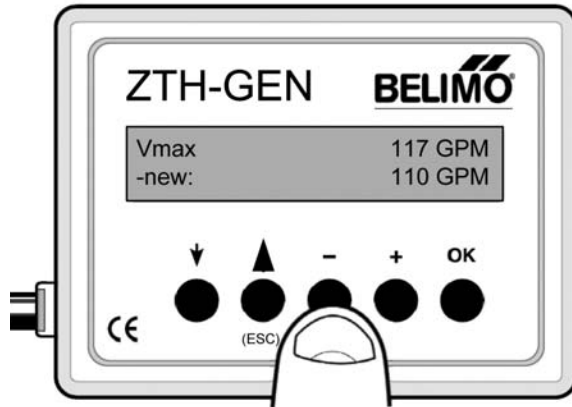

**Screen 3**

A message is displayed “Y and U5 Adjusted” for 5 seconds. Then the new Vmax value is displayed. Press ESC to continue to the next screen or simply disconnect the device from the actuator.

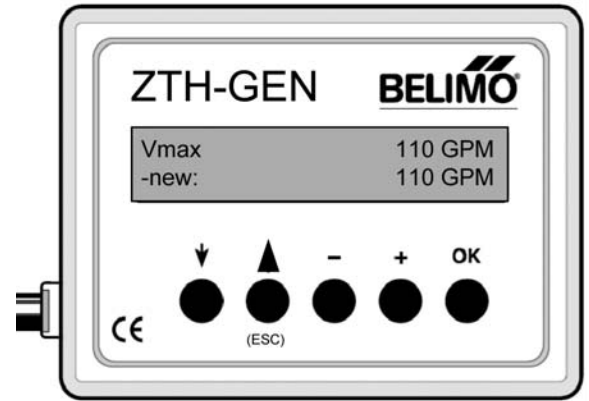

**Screen 4**

Press the +/- buttons to select different override commands, once selected press OK to execute.

- AUTO: Automatic Operation
- OPEN: Overrides the valve to the maximum aperture (90°)
- CLOSE: Overrides the valve to minimum aperture (0°)
- Vmax: Overrides the valve to its maximum GPM
- STOP: Overrides the valve to the last valve position

Note: the override remains active even after you disconnect the ZTH-GEN, it is released using the AUTO command or cycling power on the actuator.

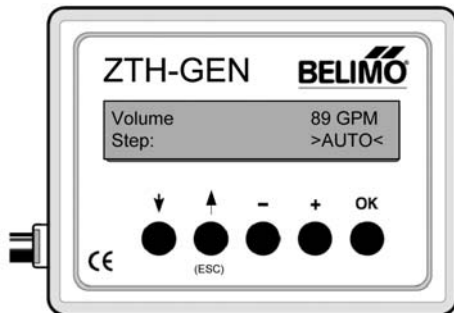

**Screen 5**

This screen displays the current GPM and valve position. This is used for troubleshooting. A small valve position and big GPM reading might indicate overpressure in the system. A small flow and a big valve position might indicate that there is not enough flow or pressure in the system

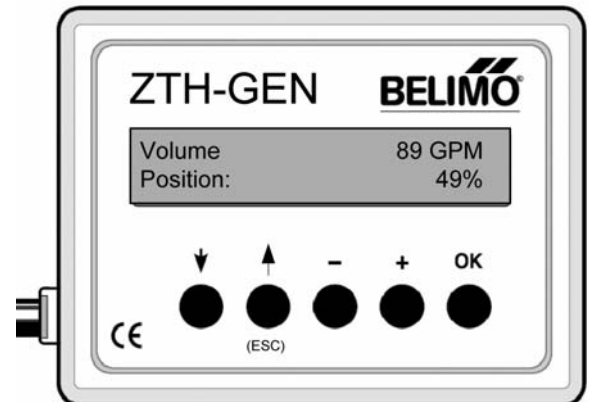

**Screen 6**

This screen displays the current GPM and the setpoint send by the controller. The voltage signal is converted to GPM in the actuator. This can be used to troubleshooting to verify the signal send by the controller and to verify Setpoint vs. Actual flow.

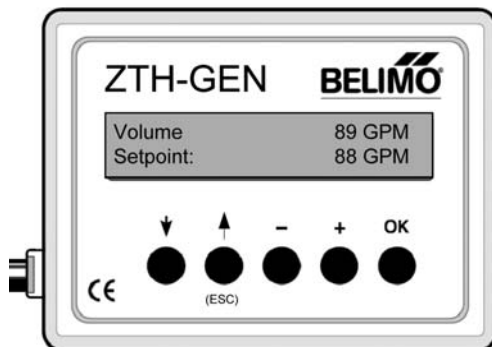

### DISPLAY SCALING PROCEDURE

During flow verification it is possible to have a different reading from an external calibrated flow measuring instrument compared to the flow feedback received from the ePIV sensor. The ZTH-GEN can be used to rescale the ePIV feedback signal to match the reading from the external calibrated instrument. To rescale the ePIV signal please use the following procedure:

#### Example

Valve Configuration: Vnom: 127 GPM (Maximum Capacity of the valve)  
 Vmax: 110 GPM (Coil size, the valve should already be configured for this setting prior this procedure).

During flow verification the valve is overridden from the DDC controller to its maximum GPM (Vmax: 110 GPM). Use the ZTH-GEN verify the flow, for this example it should be 110 GPM. If the valve position is 100% and the flow is not reached the flow must be increased from the pump. Then an external calibrated instrument is used to measure flow and compare it to the ZTH-GEN reading. For this scenario let's say that the instrument reading is 120 GPM. Based on this reading, the ePIV needs to be rescaled to reflect the same value measured by the external instrument.

### CALIBRATION INSTRUCTIONS

#### Step 1

Enable the Advanced and Expert Modes. Press the OK button before powering up the ZTH-GEN. Then connect the handheld to the actuator and release the OK button when the Configuration Menu screen appears. Using the arrow keys scroll down to the Advanced Mode screen, press the + button to change the value to 1, press OK to set the value. Scroll down to the Expert Mode screen and change its value to 1. Then scroll down to leave config-menu screen and press OK. This procedure enables a new screen called Display Scaling.

#### Step 2

From the DDC controller override the valve to 100% open (10 VDC for NC, or 2 VDC for NO),  
 Note: The valve will not necessarily rotate to 90° position, since it will try to maintain Vmax. The valve position will vary depending on the system pressure.

#### Step 3

Using the arrow keys scroll down to the Volume and Setpoint screen. The Setpoint coming from the DDC controller should be Vmax (100%). The Volume should be the same as the setpoint +/- 2. If the valve can't reach the setpoint and the valve position is 100% open (90° position) the flow should be increased from the pump. Compare the Volume value with the measurement from the external calibrated instrument, and follow the following steps to adjust the reading.

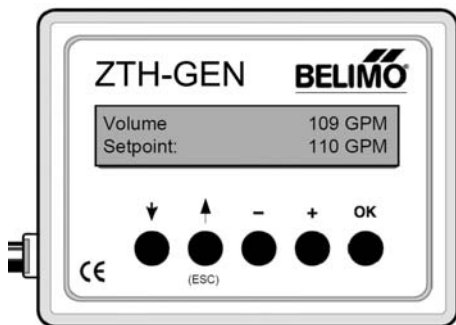

#### Step 4

Using the arrow keys scroll down to the Display Scaling screen and press OK, then using the + / - buttons change the Vol. value to the value read by the external calibrated flow instrument. In our example it is 120. Finally press OK. And the Vnom value will also change.

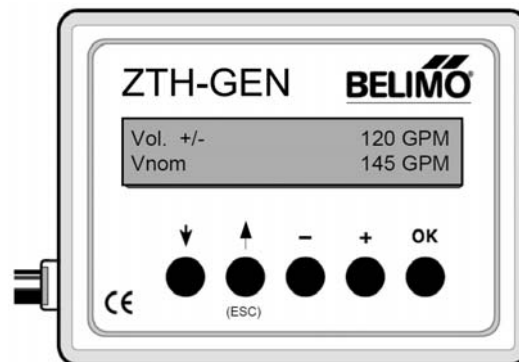

### Step 5

Using the arrow keys scroll down to the Vmax screen and use the +/- keys to set the Vmax back to the Coil value. Press OK to set the value. In our example, Vmax is 126 GPM, this step will reposition the valve so the flow feedback matches the reading taken by the external calibrated flow instrument.

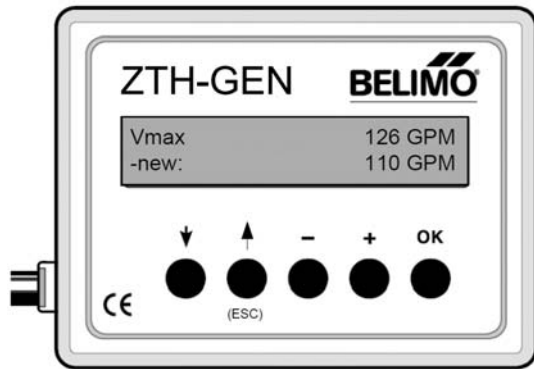

### Step 6

Scroll down to the Volume and Setpoint screen. Verify that the Volume value matches the flow reading from the external calibrated device.

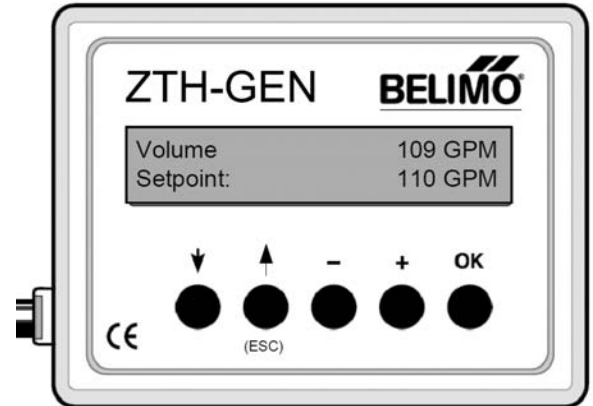

Troubleshooting					
Problem	Green LED	Valve Position	Feedback Signal	Possible Cause	Possible Solution
The LED on the actuator is not green	OFF	Static on the last position	-	<ul style="list-style-type: none"> <li>The actuator is not powered.</li> <li>The actuator is out of service</li> </ul>	<ul style="list-style-type: none"> <li>Verify the power supply and the electrical components (fuse, on/switches, etc)</li> <li>If the actuator is out of service send the actuator and the sensor back to Belimo, please do not disconnect the assembly.</li> </ul>
Requested flow can not be reached: U5 is lower than Y	ON	Fully Open	Below setpoint U5<Y	Dp is too low. The requested flow can not be reached.	Increase the pump power
Wrong flow rate measurements	ON	-	-	<ul style="list-style-type: none"> <li>"Scaling adjusted" PC-Tool or ZTH-GEN.</li> <li>Requirements regarding media are not taken into consideration.</li> <li>5x DN as an inlet length is not taken into consideration.</li> <li>The installation wiring is not equipotential.</li> <li>Dp too high</li> </ul>	<ul style="list-style-type: none"> <li>Default to factory settings.</li> <li>Check the datasheet for media options.</li> <li>Piping should be modified to fulfill the minimum inlet length.</li> <li>Check earth ground connection.</li> <li>Adjust the Dp to lower value.</li> </ul>
Flow measurements are not stable.	ON	Cyclic Movement	-	The electrodes are not in proper contact with the fluid.	<ul style="list-style-type: none"> <li>Remove air from the system.</li> <li>Verify proper installation.</li> <li>Ensure electrodes are always in contact with the fluid.</li> </ul>

09/10 - Subject to change. © Belimo Aircontrols (USA), Inc.

Belimo worldwide: [www.belimo.com](http://www.belimo.com)

**BELIMO Americas**

USA Locations, 43 Old Ridgebury Road, Danbury, CT 06810  
Tel. 800-543-9038, Fax 800-228-8283, [marketing@us.belimo.com](mailto:marketing@us.belimo.com)

1049 Fortunato Loop, Sparks, NV 89436  
Tel. 800-987-9042, Fax 800-987-8875, [marketing@us.belimo.com](mailto:marketing@us.belimo.com)

Canada Locations, 14/16 – 5716 Coopers Avenue, Mississauga, Ontario L4Z 2E8  
Tel. 866-805-7089, Fax 905-712-3124, [marketing@us.belimo.com](mailto:marketing@us.belimo.com)

Latin America and The Caribbean Customer Service  
Tel. 203-791-8396, Fax 203-791-9139, [marketing@us.belimo.com](mailto:marketing@us.belimo.com)

